

IEC 60947-2, EN60947-2, GB 14048.2



The JB is a DC circuit breaker dedicated to multi string photovoltaic installations.

This circuit breaker is designed to protect the cables located between each string of photovoltaic modules and the photovoltaic inverter against overloads and short circuits (see application diagram).

Combined with a switch, the JB will be installed in a string PV protection enclosure at the end of each string of photovoltaic modules.

It can be locked (by a padlocking device) in OFF position as a safety measure for removal of the PV inverter.

Since a fault current can flow in the reverse direction to the operating current, the JB can detect and protect against any bidirectional current.

To ensure the safety of the installation, it is necessary, depending on the various types of application, to combine the JB with:

- ✓ Residual current device at the AC end,
 - ✓ Fault passage detector (insulation monitoring device) at the DC end
 - ✓ DQ HDUWK SURWHFWLRQ FLUFXLW EUHDNHU DW WKH ' &
- In all cases, fast action on site will be required to clear the fault (protection not ensured in the event of a double fault).

JB is not polarity sensitive: (+) and (-) wires can be inverted without any risk.

The JB is delivered with three inter-pole barriers to provide increased isolation distance between two adjacent connectors.

Meaning and classification models

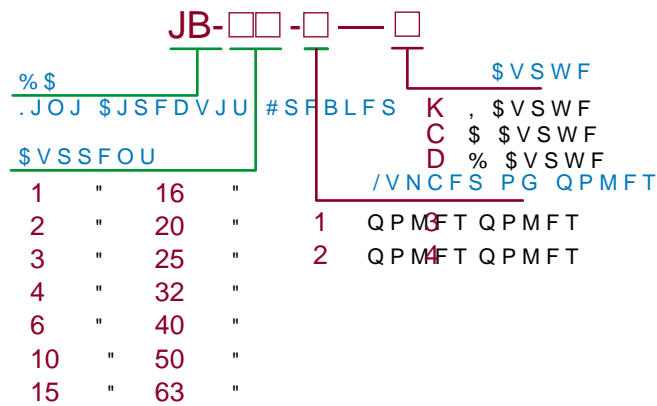

Main characteristics

Operating voltage (Ue)	1P=250 V DC, 2P=500 V DC 3P=750 V DC, 4P=1000 V DC
Rated insulation voltage (Ui)	1,000 V DC
Breaking capacity (Icu)	10 kA
Impulse voltage (Uimp)	4 kV
Electrical connection	By the bottom for In and Out
Number of poles	1P, 2P, 3P, 4P
Standards	IEC 60947-2 EN 60947-2

Technical data

- v Position contact indication - suitability for isolation according to IEC/EN 60947-2 standard.
- v The presence of the green strip guarantees physical opening of the contacts and allows operations to be performed on the downstream circuit in complete safety.
- v Increased product service life thanks to fast closing independent of the speed of actuation of the toggle.
- v Pre-wired product: Input / Output on the same side.

Main characteristics		
Rated service breaking capacity (Ics)		100 % of the Icu
Endurance (O-C)	Electrical	1,500 cycles (where L/R=2 ms)
	Mechanical	20,000 cycles
Mechanical		20,000 cycles
Degree of pollution		2
Category		A (no delay in accordance with IEC / EN 60947-2 standards)
Degree of protection (IEC 60529)	Device in modular enclosure	IP40
Tropicalisation		Relative humidity: 95 % at 55°C in accordance with IEC 60068-2 and GB 14048.2 standards
Temperature	Operating	-25°C to 70 °C
	Storage	-40°C to 85°C

Diagrams

1P: 250V DC

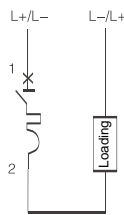

2P: 500V DC

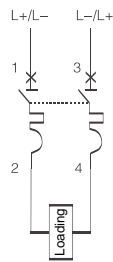

3P: 750V DC

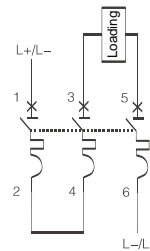

4P: 1000V DC

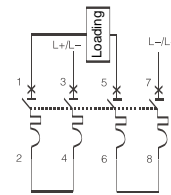

Installation

Weight (g)

Circuit breaker

Type	1P	2P	3P	4P
	120	240	360	480

Dimensions (mm)

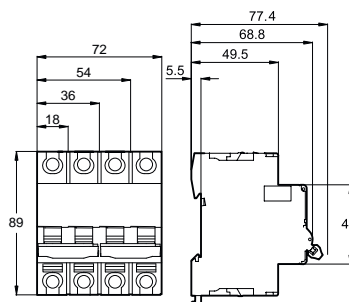

Connection

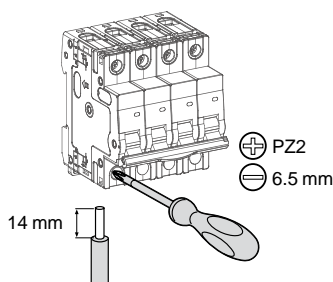

Tightening torque	Without accessory		With accessories	
	Copper cables		50 mm ² Cu/Al Terminal	Ring tongue terminal screw connection
2.5 N.m	Rigids	Flexibles with ferrule	50 mm ²	Ø 5 mm
	1 to 25 mm ²	1 to 16 mm ²		

Curve

C curve

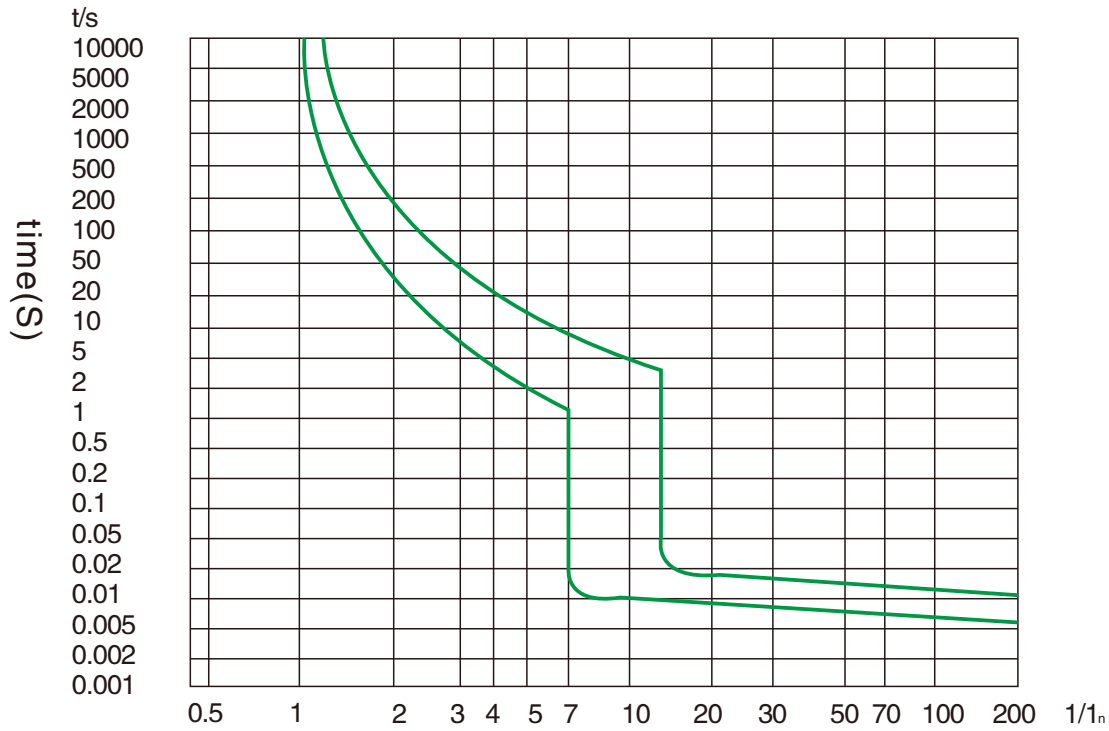

K curve

